

Introduction to the Theory of Thermal Neutron Scattering

G.L. Squires

Dover Publications Inc.; New Edition (1997)

Elements of Modern X-ray Physics

Jens Als-Nielsen, Des McMorrow

John Wiley and Sons Ltd (2000)

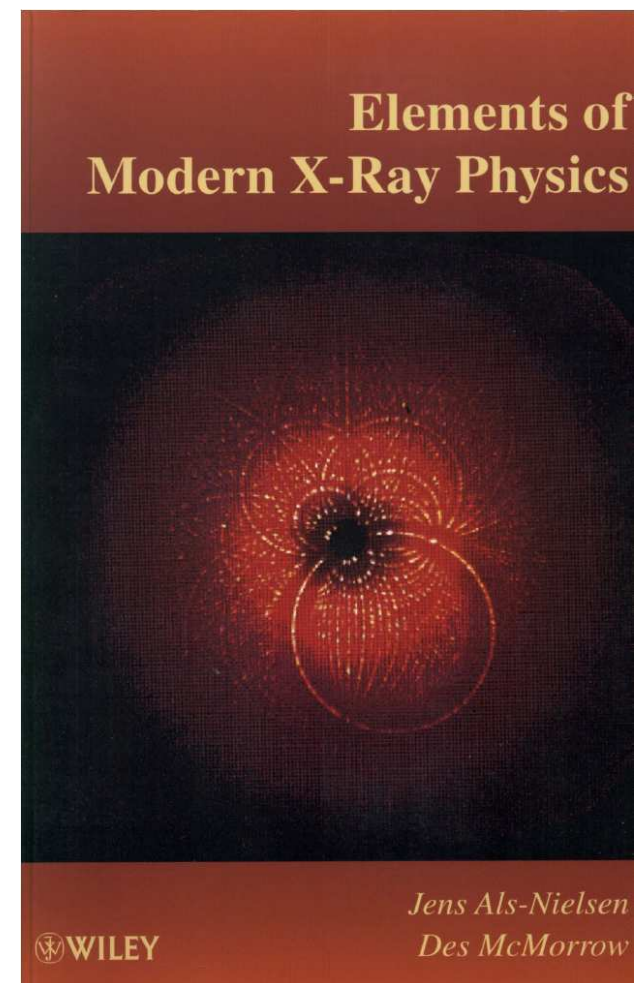

Röntgen-Tomographie



Sinogramm: jeweils eine Zeile

↑ Winkel

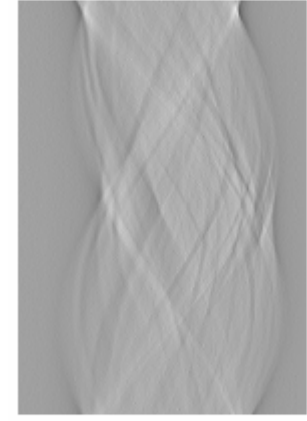
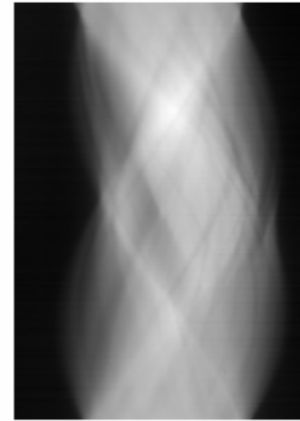
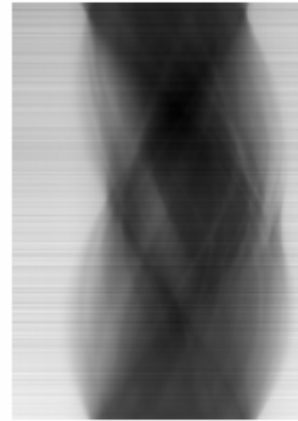

Bilder (original, korrigiert)

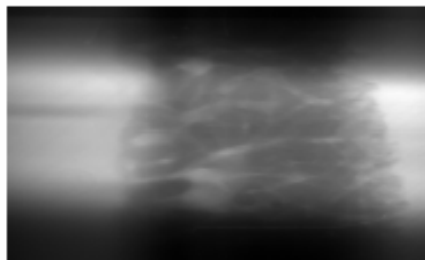

(bei einem Winkel)

Rekonstruktion

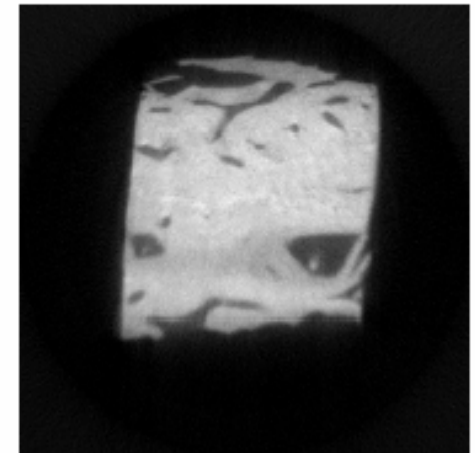

Walkknochen: *In situ* Deformation, Tomographie

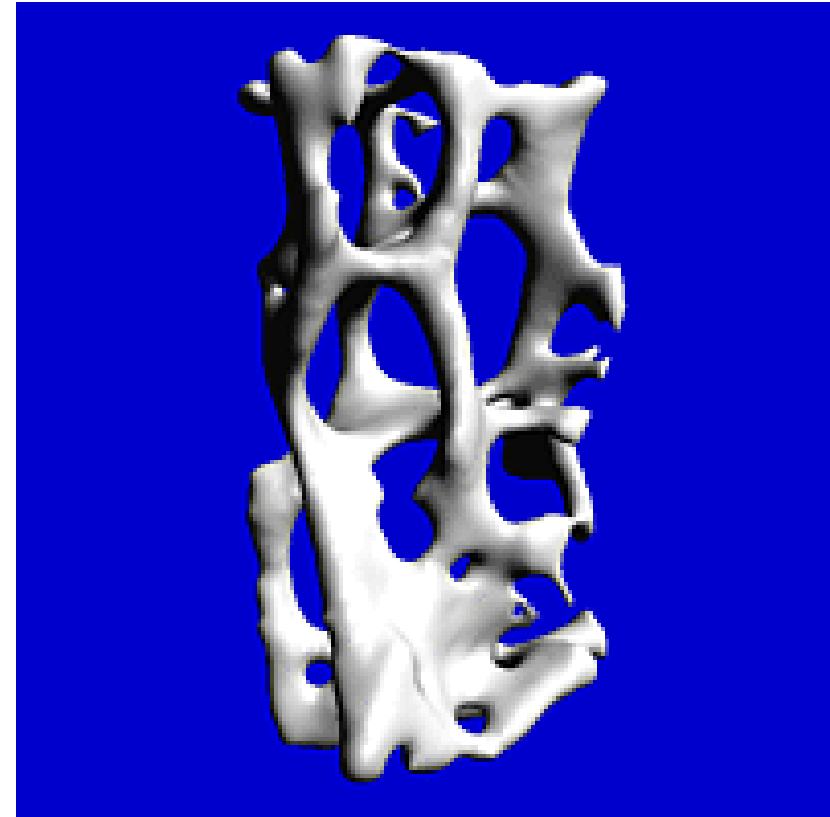
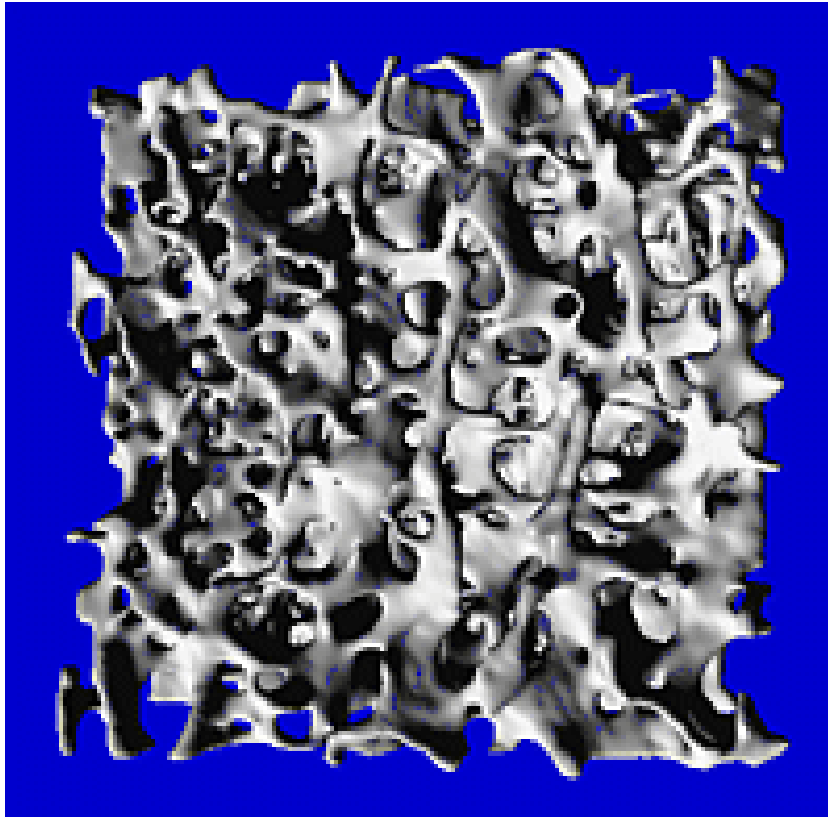

lokale Information über mechanisches Versagen

R. Müller *et al.*, *Technology and Health Care* **6**, 433-444 (1998)

Kohärenz

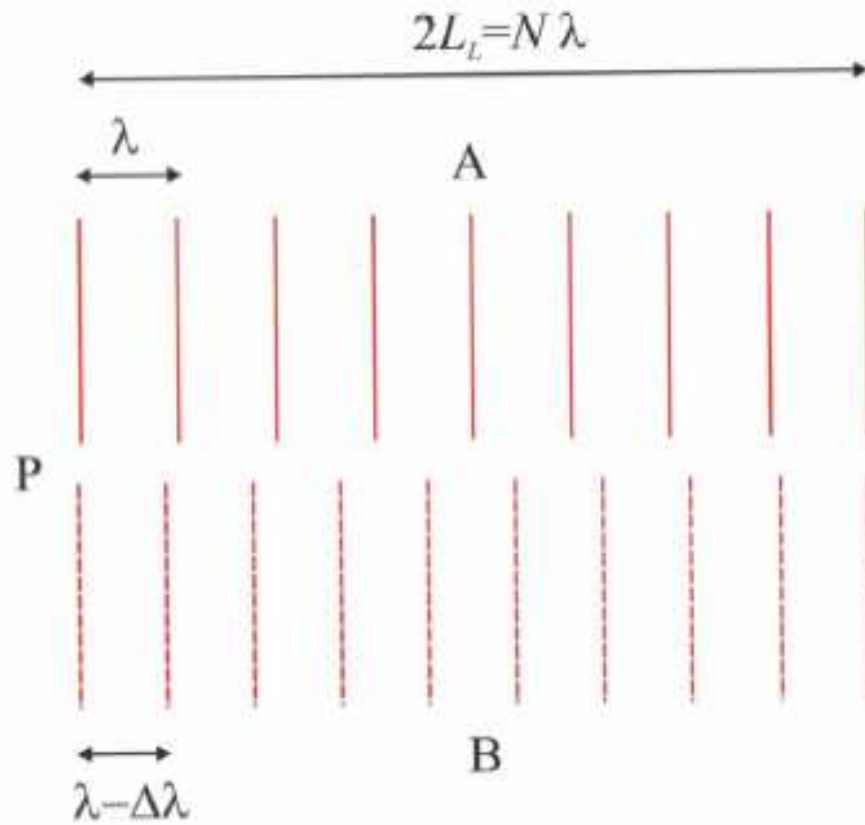

longitudinale
Kohärenzlänge

transversale
Kohärenzlänge

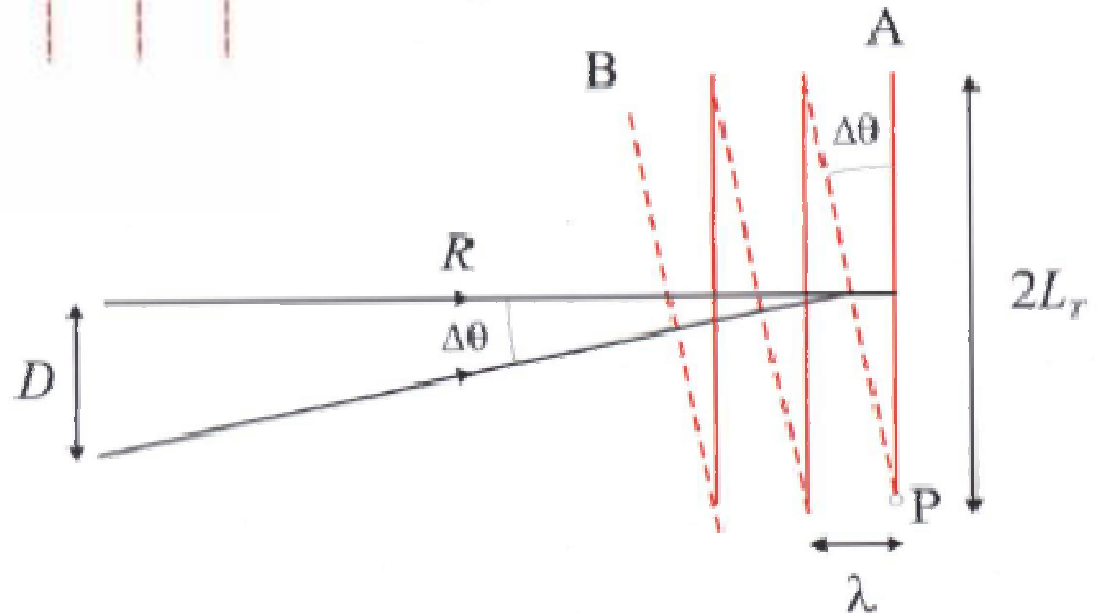

Kohärentes Imaging

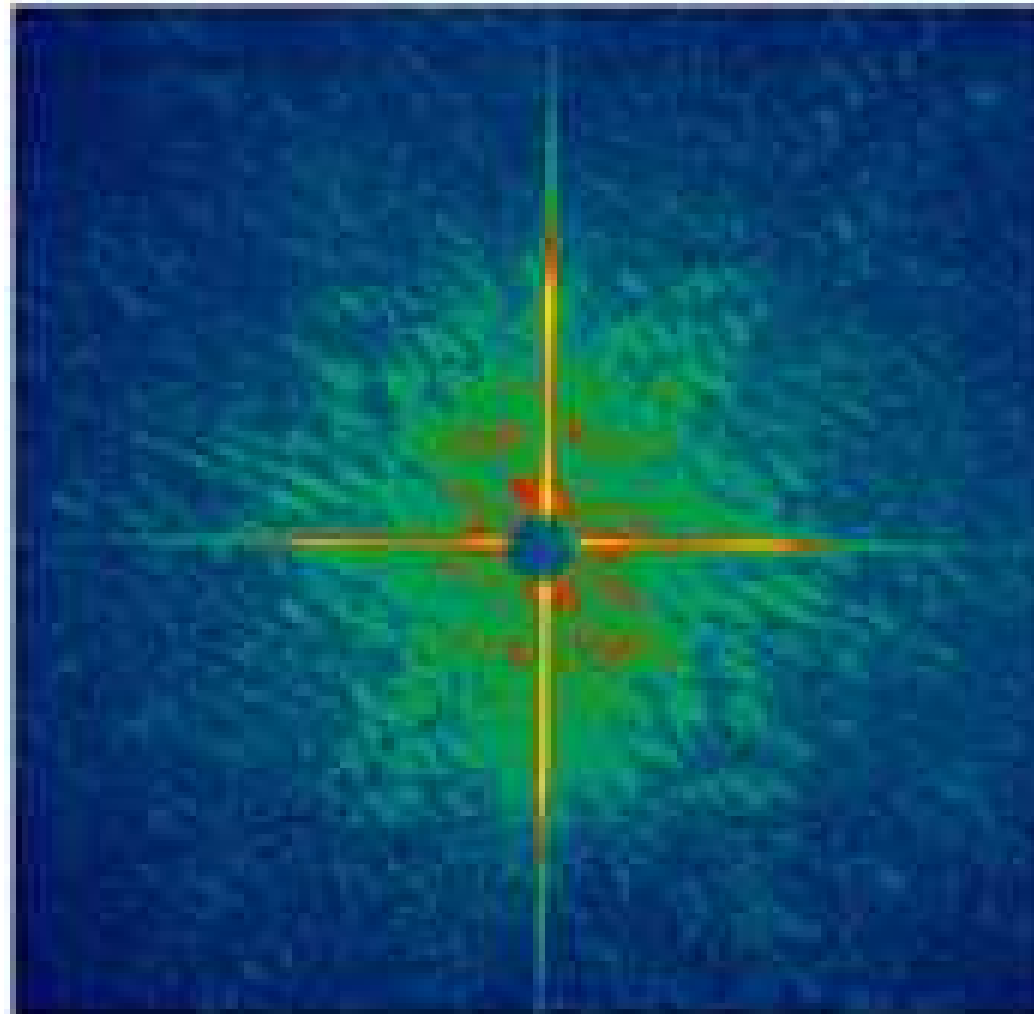

Maxwell-Verteilung für kalte, thermische und heiße Neutronen

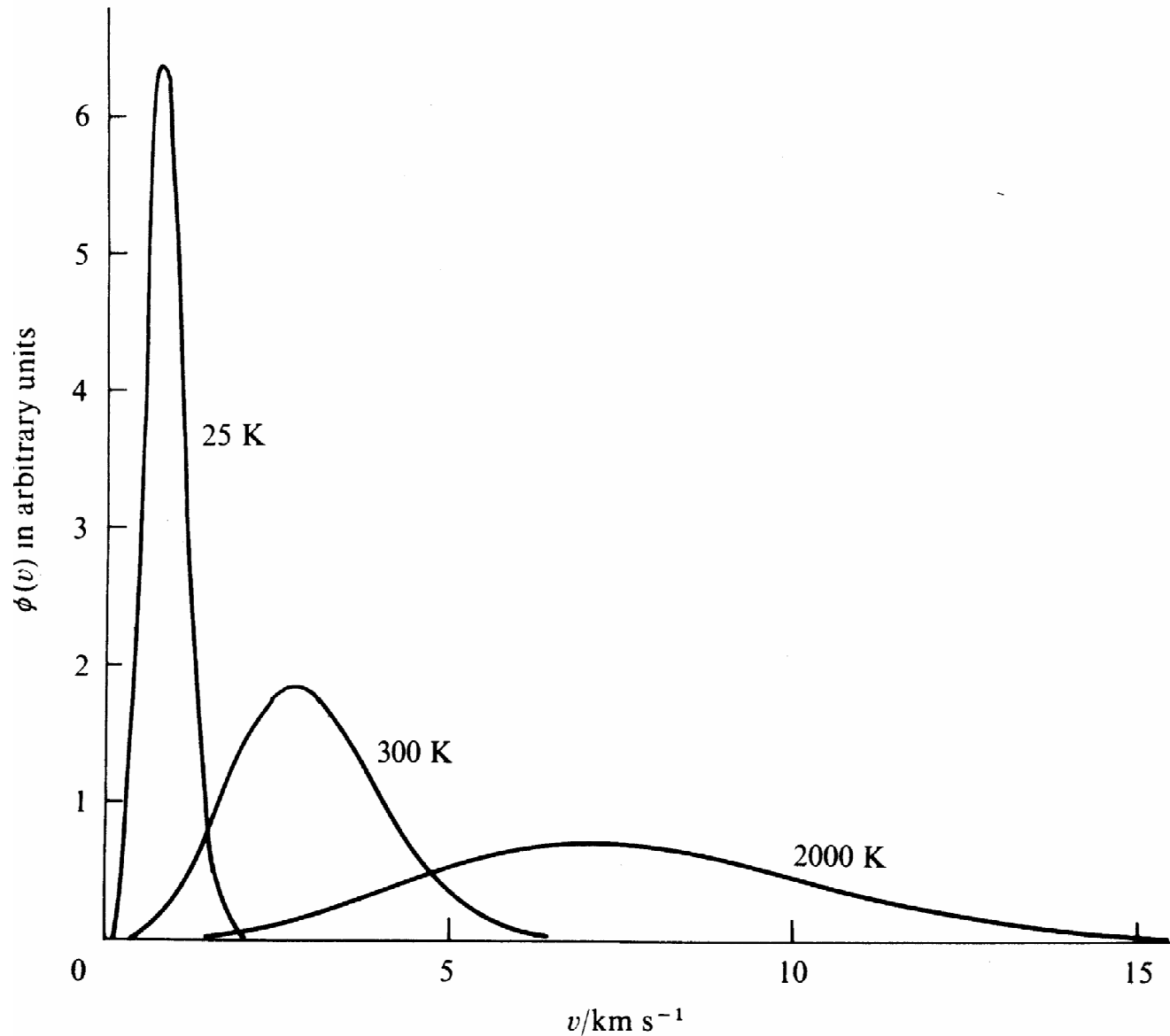

WH: Streugeometrie

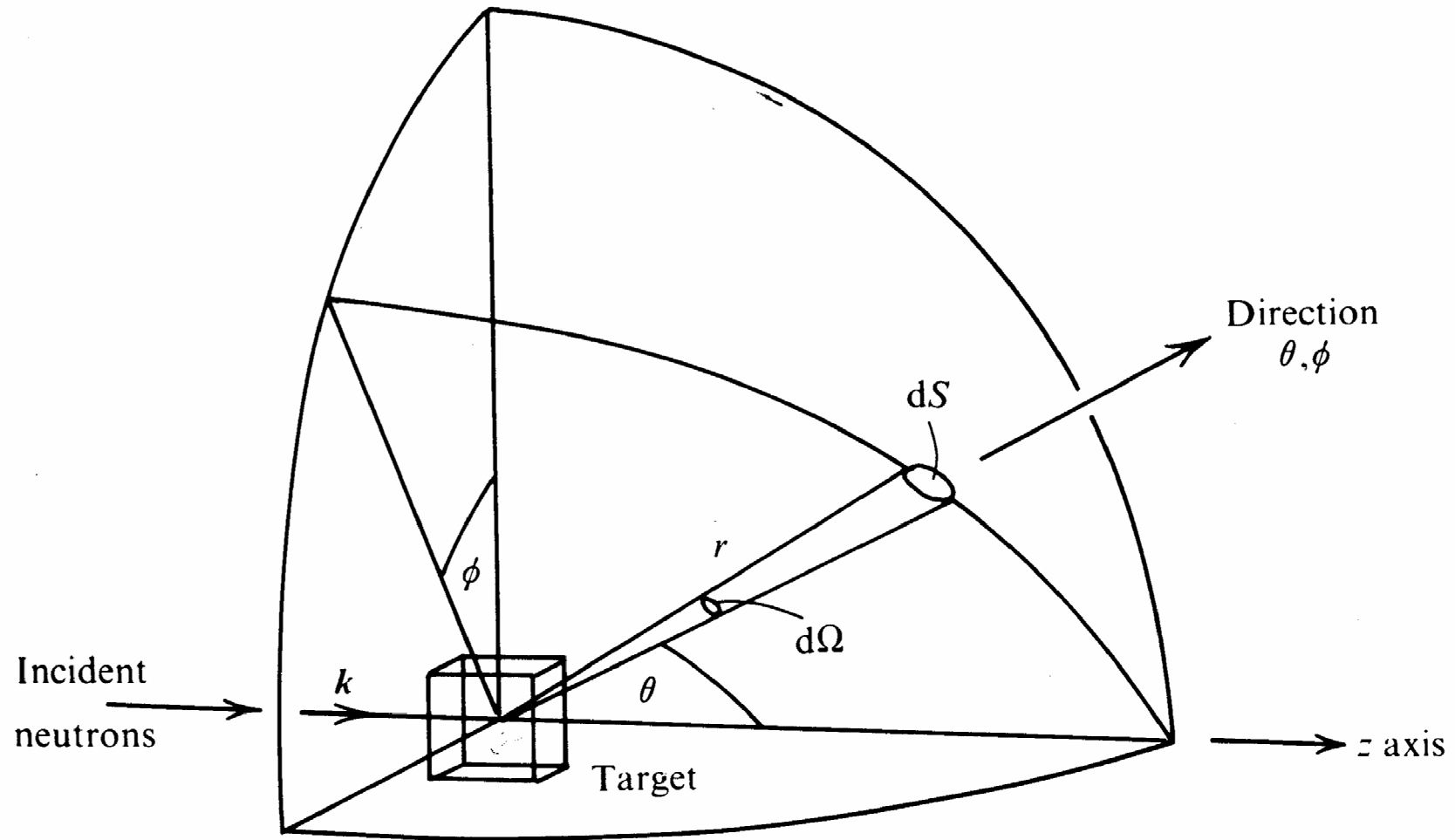

Koordinatensystem zur Streutheorie

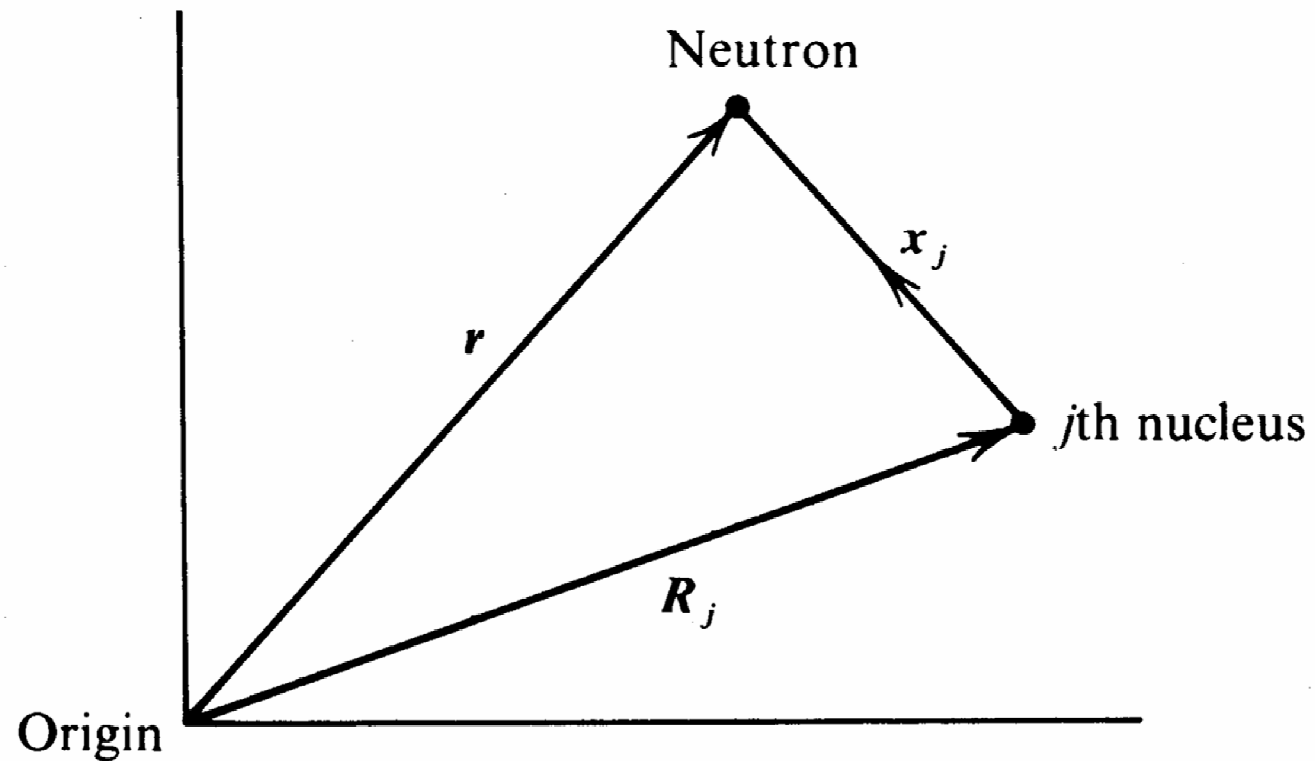

Zur Berechnung der Zustandsdichte

